

■ Patented protected screw



Applications / Customer Benefits

- Highly precise self-centering clamping with maximum repeatability
- Totally protected
- Compact design for better accessibility and very large drainage slots
- Jaws with SinterGrip clamping inserts for minimum workpiece clamping depth without pre-machining
- Wide clamping range
- Ideal for OP 10 and OP 20

Technical features

- Self-centering clamping
- Clamping force up to 40 kN (70 Nm)
- Jaw width 160 mm
- Interface for zero point systems APS / WPS and Lang 96 mm as standard

Standard equipment

Wrench, jaws, Sintergrip inserts.

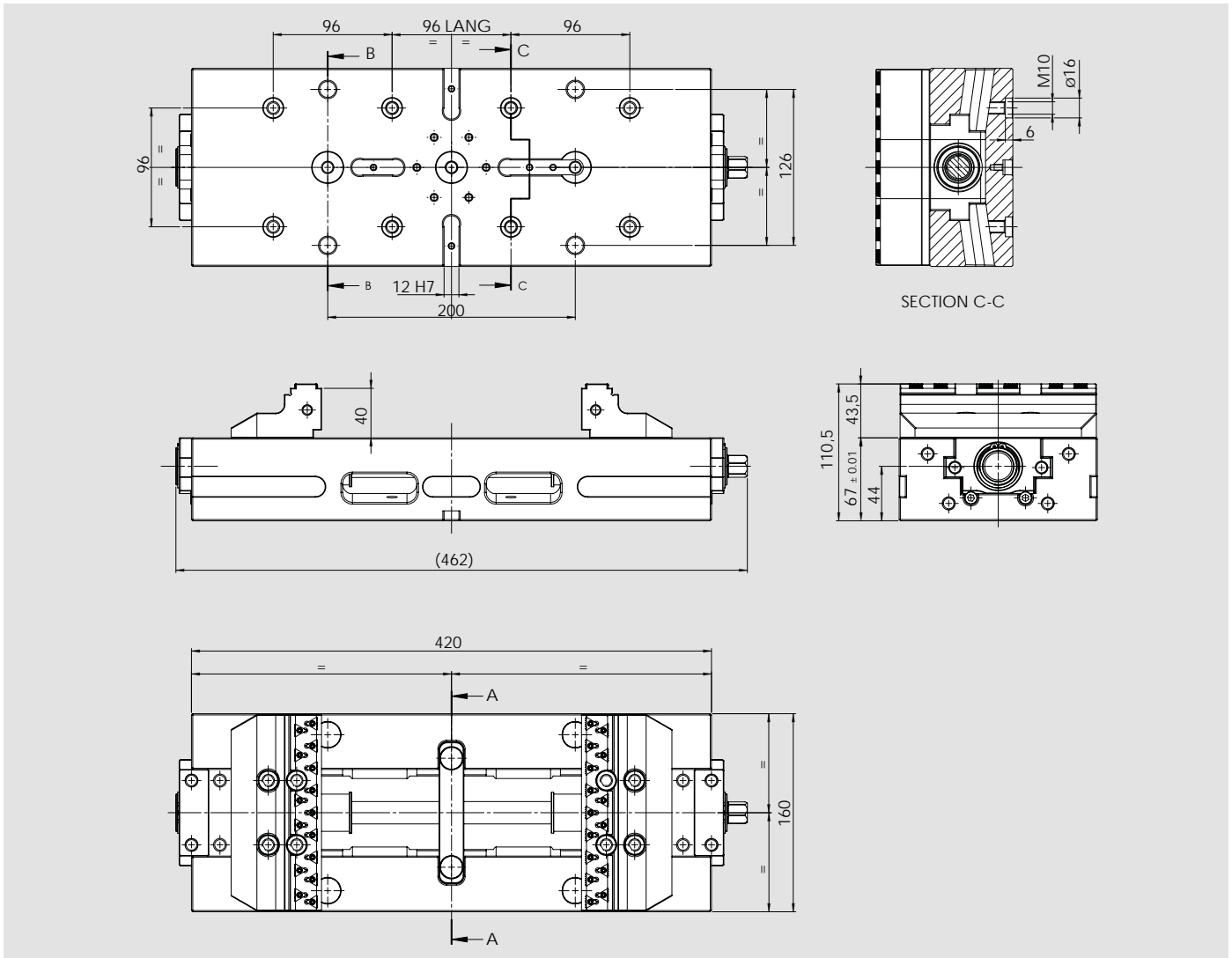

Type	Id. No.	Weight
IMG 160 - 420 with SinterGrip jaws STD	77583621	32 Kg
IMG 160 - 420 with SinterGrip jaws ALU	77583622	32 Kg
IMG 160 - 420 with SinterGrip jaws HRC	77583623	32 Kg

■ Patented protected screw

Self-centering

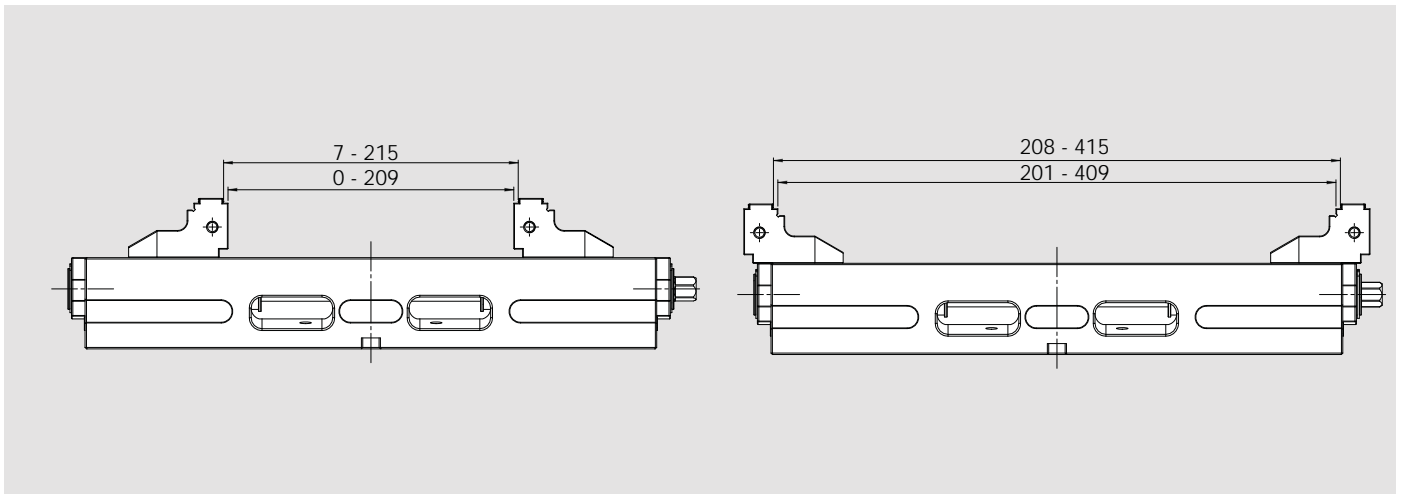

Double Clamping

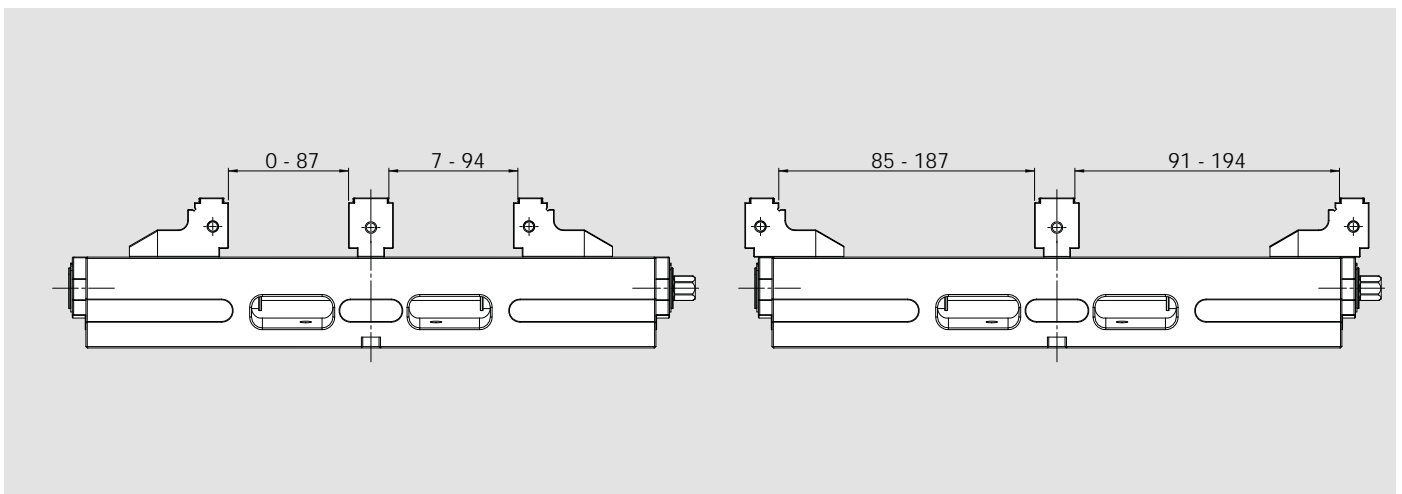

Fixed

